



Seduzione, lusso, purezza,
ma senza entrare in conflitto
con la modernità e la funzionalità.

Seduction, luxury and purity
which does not clash
with modernity and functionality.

Seducción, lujo, pureza
que no entran en conflicto
con la modernidad y la funcionalidad.

ROYAL



L
3/45
water saving

Consumo d'acqua
Water flush
Consumo de agua

Installazione:
Installation:
Instalación:



Sospeso
Wall hung
Suspendido



Appoggio
Sit on top
Apoyo



Su colonna
With pedestal
Con pedestal



Con piedini
With legs
Con patas



Sottopiano
Under-counter
Bajo encimera



Semincasso
Semi recessed
Semiencastré



Su mobile
Cabinet basin
Con mueble

45 ROYAL

45x45

KG 15 Lavabo Royal angolare monoforo con troppopieno
Royal corner one tap hole basin with overflow
Lavabo Royal angular para monomando con rebosadero

30353 white	€ 264,00
40769 black	€ 396,00

ARTICOLI SUPPLEMENTARI
ADDITIONAL ITEMS
ARTICULOS ADICIONALES

KG 0,1 Fissaggi per lavabo
Fixings for washbasin
Anclajes para lavabo

30020 **€ 4,50**

85 ROYAL

85x45

KG 23 Consolle Royal cm 85 con troppopieno
Royal console cm 85 with overflow
Consola Royal cm 85 con rebosadero

Monoforo One tap hole Para monomando	Tre fori Three tap hole Tres agujeros
30355 white	30355-3F white
€ 360,00	
40772 black	40772-3F black
€ 540,00	

KG 9 Coppia di piedini
Pair of legs
Pareja de patas

40408 white **€ 274,00**

40787 black **€ 411,00**

40788 platinum
40789 gold **€ 685,00**

ARTICOLI SUPPLEMENTARI
ADDITIONAL ITEMS
ARTICULOS ADICIONALES

KG 0,1 Fissaggi per lavabo
Fixings for washbasin
Anclajes para lavabo

30020 **€ 4,50**

56 ROYAL

56x45

KG 12 Lavabo Royal semincasso monoforo con troppopieno
Royal semi recessed one tap hole basin with overflow
Lavabo Royal semiencastrate para monomando con rebosadero

30354 white	€ 244,00
40770 black	€ 366,00

KG 0,1 Fissaggi per lavabo
Fixings for washbasin
Anclajes para lavabo

30020 **€ 4,50**

105 ROYAL

105x45

KG 25 Consolle Royal cm 105 con troppopieno
Royal console cm 105 with overflow
Consola Royal cm 105 con rebosadero

Monoforo One tap hole Para monomando	Tre fori Three tap hole Tres agujeros
40127 white	40127-3F white
€ 400,00	
40773 black	40773-3F black
€ 600,00	

KG 9 Coppia di piedini
Pair of legs
Pareja de patas

40408 white **€ 274,00**

40787 black **€ 411,00**

40788 platinum
40789 gold **€ 685,00**

ARTICOLI SUPPLEMENTARI
ADDITIONAL ITEMS
ARTICULOS ADICIONALES

KG 0,1 Fissaggi per lavabo
Fixings for washbasin
Anclajes para lavabo

30020 **€ 4,50**

70 ROYAL

70x59

KG 23 Lavabo Royal con troppopieno
Royal basin with overflow
Lavabo Royal con rebosadero

Monoforo One tap hole Para monomando	Tre fori Three tap hole Tres agujeros
27021 white	27021-3F white
€ 220,00	
40771 black	40771-3F black
€ 330,00	

KG 14 Colonna
Pedestal
Pedestal

27030 white **€ 140,00**

40848 black **€ 210,00**

ARTICOLI SUPPLEMENTARI
ADDITIONAL ITEMS
ARTICULOS ADICIONALES

KG 0,1 Fissaggi per lavabo
Fixings for washbasin
Anclajes para lavabo

30020 **€ 4,50**

110 ROYAL

110x61

KG 32 Consolle Royal cm 110 con troppopieno
Royal console cm 110 with overflow
Consola Royal cm 110 con rebosadero

Monoforo One tap hole Para monomando	Tre fori Three tap hole Tres agujeros
40129 white	40129-3F white
€ 742,00	
40774 black	40774-3F black
€ 1.113,00	

KG 9 Coppia di piedini
Pair of legs
Pareja de patas

40408 white **€ 274,00**

40787 black **€ 411,00**

40788 platinum
40789 gold **€ 685,00**

ARTICOLI SUPPLEMENTARI
ADDITIONAL ITEMS
ARTICULOS ADICIONALES

KG 0,1 Fissaggi per lavabo
Fixings for washbasin
Anclajes para lavabo

30020 **€ 4,50**

110 ROYAL

110x55

KS 47 Consolle Royal Calipso con troppopieno
Royal Calipso console with overflow
Consola Royal Calipso con rebosadero

Monoforo One tap hole Para monomando	Tre fori Three tap hole Tres agujeros
30060 white	30060-3F white
€ 742,00	
40775 black	40775-3F black
€ 1.113,00	

KS 8 Coppia di piedini
Pair of legs
Pareja de patas

40191 white	€ 274,00
40793 black	€ 411,00
40794 platinum	
40869 gold	€ 685,00

ARTICOLI SUPPLEMENTARI
ADDITIONAL ITEMS
ARTICULOS ADICIONALES

KS 41 Fissaggi per lavabo
Fixings for washbasin
Anclajes para lavabo

30020	€ 4,50
-------	---------------

57 ROYAL

57x36

KS 20 Bidet con troppopieno
Bidet with overflow
Bidé con rebosadero

Monoforo One tap hole Para monomando	Tre fori Three tap hole Tres agujeros
27040 white	27040-3F white
€ 265,00	
40776 black	40776-3F black
€ 398,00	

ARTICOLI SUPPLEMENTARI
ADDITIONAL ITEMS
ARTICULOS ADICIONALES

KS 0,03 Fissaggio per vaso e bidet
Fixings for WC - bidet
Anclajes para inodoro - bidé

520/A	€ 4,50
-------	---------------

63 ROYAL

63x32

KS 14 Colonna
Pedestal
Pedestal

27030 white	€ 140,00
40848 black	€ 210,00

83 ROYAL

83x12

KS 9 Coppia di piedini per consolle Royal cm 85 - 105 - 110
Pair of legs for console Royal cm 85 - 105 - 110
Pareja de patas para consola Royal cm 85 - 105 - 110

40408 white	€ 274,00
40787 black	€ 411,00
40788 platinum	
40789 gold	€ 685,00

75 ROYAL

75x12

KS 8 Coppia di piedini per consolle Royal Calipso
Pair of legs for Royal Calipso console
Pareja de patas para consola Royal Calipso

40191 white	€ 274,00
40793 black	€ 411,00
40794 platinum	
40869 gold	€ 685,00

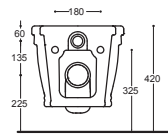
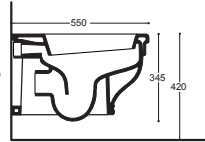
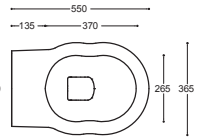

55 ROYAL

55x36



KG 20

WC sospeso
Wall hung WC
Inodoro suspendido

40954 white € 376,00

40956 black € 564,00

ARTICOLI SUPPLEMENTARI
ADDITIONAL ITEMS
ARTICULOS ADICIONALES

KG 4

Coprivaso in resina termoindurente - cerniere cromo
Thermosetting resin seat cover - chrome hinges
Asiento de resina termoindurente - bisagras cromo

27050 white € 76,00

40868 black
27052 wood € 130,00

KG 4

Coprivaso frizionato in resina termoindurente - cerniere cromo
Thermosetting resin soft close seat cover - chrome hinges
Asiento amortiguado de resina termoindurente - bisagras cromo

40409 white € 180,00

40870 black
40412 wood € 240,00

KG 3

Staffa di fissaggio per vaso e bidet sospesi
Bracket for wall hung WC - bidet
Estrubo a "L" para inodoro - bidé suspendidos

30019 € 43,00

FISSAGGI CONSIGLIATI
Per un fissaggio rapido ed agevolato

RECOMMENDED FIXINGS
For a quick and easy fixing

ANCLAJES RECOMENDADOS
Para una fijación rápida y facilitada



KG 0,3

Kit di fissaggio rapido per vaso e bidet sospesi
Quick fixing kit for wall hung WC - bidet
Kit de montaje rápido para inodoro - bidé suspendidos

40951 € 38,00

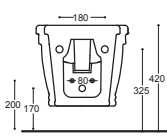
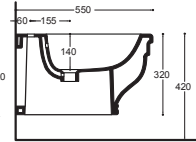
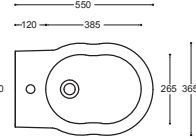

55 ROYAL

55x36



KG 19

Bidet sospeso con troppopieno
Wall hung bidet with overflow
Bidé suspendido con rebosadero

Monoforo Tre fori
One tap hole Three tap hole
Para monomando Tres agujeros

40955 white 40955-3F white € 376,00

40957 black 40957-3F black € 564,00

KG 5

Staffa di fissaggio per vaso e bidet sospesi
Bracket for wall hung WC - bidet
Estrubo a "L" para inodoro - bidé suspendidos

30019 € 43,00

FISSAGGI CONSIGLIATI

Per un fissaggio rapido ed agevolato

RECOMMENDED FIXINGS

For a quick and easy fixing

ANCLAJES RECOMENDADOS

Para una fijación rápida y facilitada



KG 0,3

Kit di fissaggio rapido per vaso e bidet sospesi
Quick fixing kit for wall hung WC - bidet
Kit de montaje rápido para inodoro - bidé suspendidos

40951 € 38,00

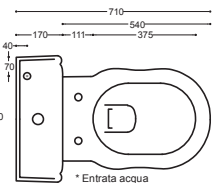

* Entrata acqua
* Inlet water
* Entrada agua

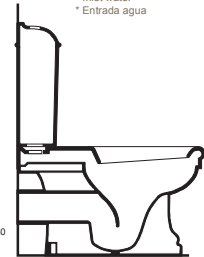

71 ROYAL

71x47



KG 22

WC monoblocco scarico a parete
Close - coupled WC wall trap
Inodoro para tanque bajo salida H

27001 white € 300,00

40779 black € 450,00

KG 15

Cassetta monoblocco
Close - coupled cistern
Tanque bajo

27014 white € 180,00

40781 black € 270,00

ARTICOLI SUPPLEMENTARI
ADDITIONAL ITEMS
ARTICULOS ADICIONALES

KG 4

Coprivaso in resina termoindurente - cerniere cromo
Thermosetting resin seat cover - chrome hinges
Asiento de resina termoindurente - bisagras cromo

27050 white € 76,00

40868 black
27052 wood € 130,00

KG 4

Coprivaso frizionato in resina termoindurente - cerniere cromo
Thermosetting resin soft close seat cover - chrome hinges
Asiento amortiguado de resina termoindurente - bisagras cromo

40409 white € 180,00

40870 black
40412 wood € 240,00

KG 0,03

Fissaggio per vaso e bidet
Fixings for WC - bidet
Anclajes para inodoro - bidé

520/A € 4,50

KG 1

Meccanismo di scarico
Mechanism for close - coupled cistern
Mecanismo de descarga

30090 € 38,00

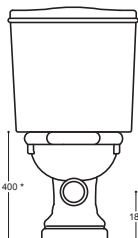

* H Entrata acqua
* H Inlet water
* H Entrada agua

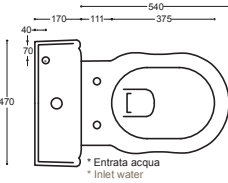

* Entrata acqua
* Inlet water
* Entrada agua

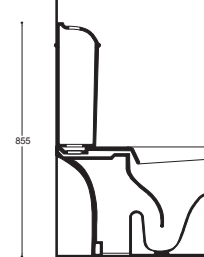

71 ROYAL

71x47



KG 22

WC monoblocco scarico a pavimento
Close - coupled WC floor trap
Inodoro para tanque bajo salida V

27002 white € 300,00

40780 black € 450,00

KG 15

Cassetta monoblocco
Close - coupled cistern
Tanque bajo

27014 white € 180,00

40781 black € 270,00

ARTICOLI SUPPLEMENTARI
ADDITIONAL ITEMS
ARTICULOS ADICIONALES

KG 4

Coprivaso in resina termoindurente - cerniere cromo
Thermosetting resin seat cover - chrome hinges
Asiento de resina termoindurente - bisagras cromo

27050 white € 76,00

40868 black
27052 wood € 130,00

KG 4

Coprivaso frizionato in resina termoindurente - cerniere cromo
Thermosetting resin soft close seat cover - chrome hinges
Asiento amortiguado de resina termoindurente - bisagras cromo

40409 white € 180,00

40870 black
40412 wood € 240,00

KG 0,03

Fissaggio per vaso e bidet
Fixings for WC - bidet
Anclajes para inodoro - bidé

520/A € 4,50

KG 1

Meccanismo di scarico
Mechanism for close - coupled cistern
Mecanismo de descarga

30090 € 38,00

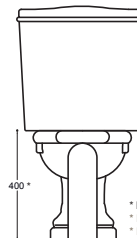



* H Entrata acqua
* H Inlet water
* H Entrada agua



55 ROYAL

55x36





KG 21 WC scarico a parete
WC wall trap
Inodoro salida H
27003 white

€ 265,00

40777 black

€ 398,00

ARTICOLI SUPPLEMENTARI
ADDITIONAL ITEMS
ARTICULOS ADICIONALES

KG 4 Coprivaso in resina termoindurente - cerniere cromo
Thermosetting resin seat cover - chrome hinges
Asiento de resina termoindurente - bisagras cromo

27050 white

€ 76,00

40868 black
27052 wood

€ 130,00

KG 4 Coprivaso frizionato in resina termoindurente - cerniere cromo
Thermosetting resin soft close seat cover - chrome hinges
Asiento amortiguado de resina termoindurente - bisagras cromo

40409 white

€ 180,00

40870 black
40412 wood

€ 240,00

KG 0,03 Fissaggio per vaso e bidet
Fixings for WC - bidet
Anclajes para inodoro - bidé
520/A

€ 4,50

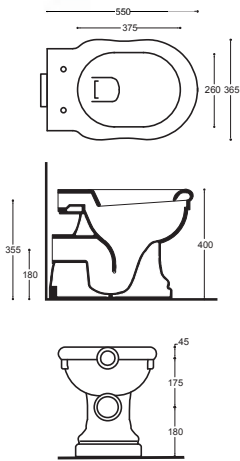



55 ROYAL

55x36





KG 21 WC scarico a pavimento
WC floor trap
Inodoro salida V
27004 white

€ 265,00

40778 black

€ 398,00

ARTICOLI SUPPLEMENTARI
ADDITIONAL ITEMS
ARTICULOS ADICIONALES

KG 4 Coprivaso in resina termoindurente - cerniere cromo
Thermosetting resin seat cover - chrome hinges
Asiento de resina termoindurente - bisagras cromo

27050 white

€ 76,00

40868 black
27052 wood

€ 130,00

KG 4 Coprivaso frizionato in resina termoindurente - cerniere cromo
Thermosetting resin soft close seat cover - chrome hinges
Asiento amortiguado de resina termoindurente - bisagras cromo

40409 white

€ 180,00

40870 black
40412 wood

€ 240,00

KG 0,03 Fissaggio per vaso e bidet
Fixings for WC - bidet
Anclajes para inodoro - bidé
520/A

€ 4,50

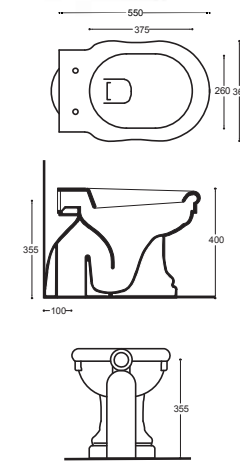



KG 16 Cassetta a zaino
Low level cistern with lid
Tanque a media altura
40288 white

€ 143,00

40783 black

€ 215,00

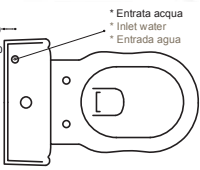

KG 0 Meccanismo di scarico per cassetta a zaino
Mechanism for low level cistern
Mecanismo de descarga para tanque a media altura
40289

€ 120,00

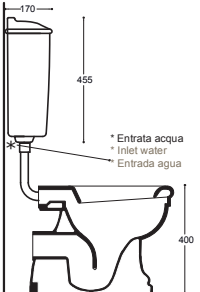



KG 0 Meccanismo con leva frontale in ceramica
Mechanism with frontal ceramic handle
Mecanismo con palanca frontal en cerámica
40987 finitura cromo - chrome metal - acabado cromo

€ 94,00

40988 finitura oro - gold metal - acabado oro
40989 finitura bronzo - bronze metal - acabado bronzo

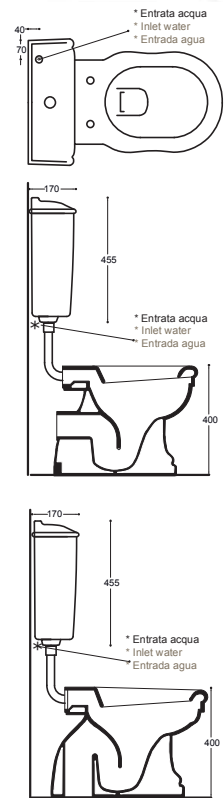
€ 104,00





KG 16 Cassetta alta con coperchio
High level cistern with lid
Tanque alto con tapa
27013 white

€ 130,00

40782 black

€ 195,00

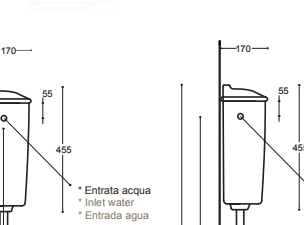

KG 0 Set per cassetta alta (tubo+catenella+meccanismo)
Set for high level cistern (pipe+chain+mechanism)
Set para tanque alto (tubo+cadena+mec)
40166 chrome

€ 400,00

40167 bronze

€ 500,00

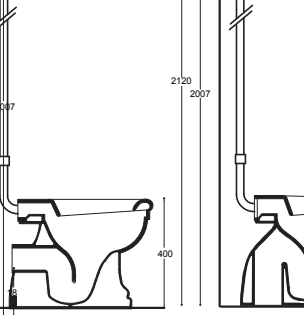

KG 0 Set per cassetta alta (catenella+meccanismo)
Set for high level cistern (chain+mechanism)
Set para tanque alto (cadena+mec)
40168 chrome

€ 280,00

40169 bronze

€ 300,00

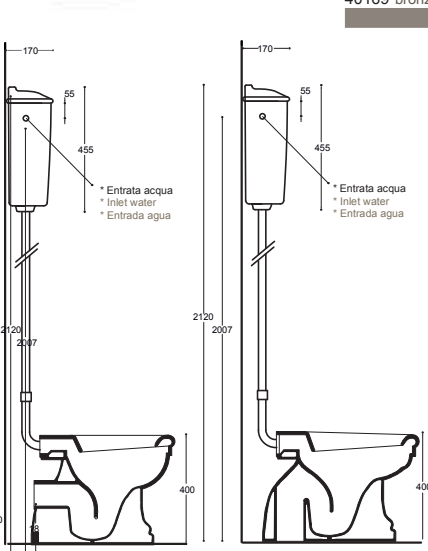



170 ROYAL

170x80

160 Vasca Royal bianca con staffe e piedini - Installazione centro stanza
 Royal bathtub with brackets and feet - Freestanding installation
 Bañera Royal blanca con pie - Instalación freestanding

40859 white/chrome metal feet

40860 white/white metal feet

€ 2.300,00

40861 white/bronze metal feet

40862 white/gold metal feet

€ 2.500,00

160 Kit colonna scarico e sifone

Drain column and syphon kit

Kit tubo de descarga

40863 chrome metal kit

40864 white metal kit

€ 560,00

40865 bronze metal kit

40866 gold metal kit

€ 600,00

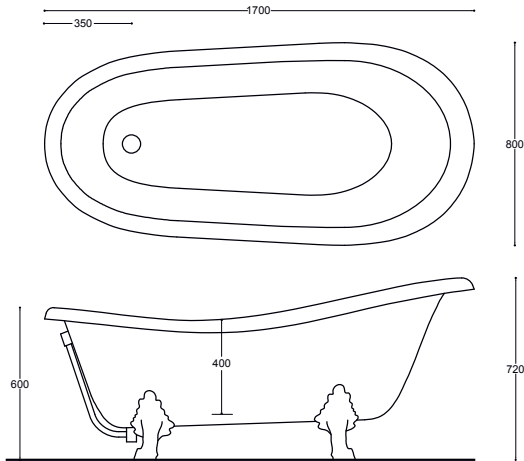



Le sue forme rendono l'intera serie un classico intramontabile, capace di sfidare le mode.

Its shapes makes this entire series a timeless classic capable of defying changing fashions.

Sus formas convierten todo el conjunto en un clásico que no decade y que puede desafiar a las modas.

ROSE



L
3/45
water saving
Consumo d'acqua
Water flush
Consumo de agua

Installazione:
Installation:
Instalación:



Sospeso
Wall hung
Suspendido



Appoggio
Sit on top
Apoyo



Su colonna
With pedestal
Con pedestal



Con piedini
With legs
Con patas



Sottopiano
Under-counter
Bajo encimera



Semincasso
Semi recessed
Semiencastré



Su mobile
Cabinet basin
Con mueble

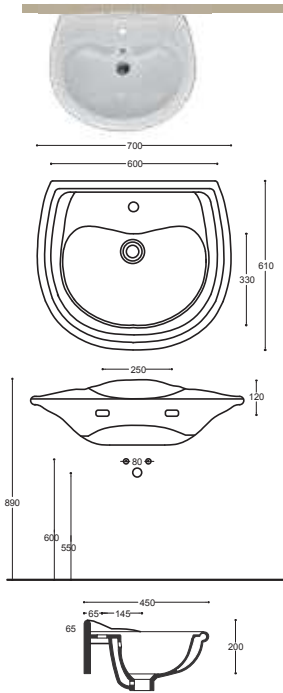

70 ROSE

70x61



- KG 19** Lavabo Rose con troppopieno
Rose basin with overflow
Lavabo Rose con rebosadero
- | | |
|--|---|
| Monoforo
One tap hole
Para monomando | Tre fori
Three tap hole
Tres agujeros |
| 24021 white | 24021-3F white |
| € 190,00 | |
| 40926 black | 40926-3F black |
| € 285,00 | |

- KG 11** Colonna
Pedestal
Pedestal
24030 white
- € 137,00**
- 40927 black
- € 206,00**

ARTICOLI SUPPLEMENTARI ADDITIONAL ITEMS ARTICULOS ADICIONALES

- KG 03** Fissaggi per lavabo
Fixings for washbasin
Anclajes para lavabo
- 30020
- € 4,50**

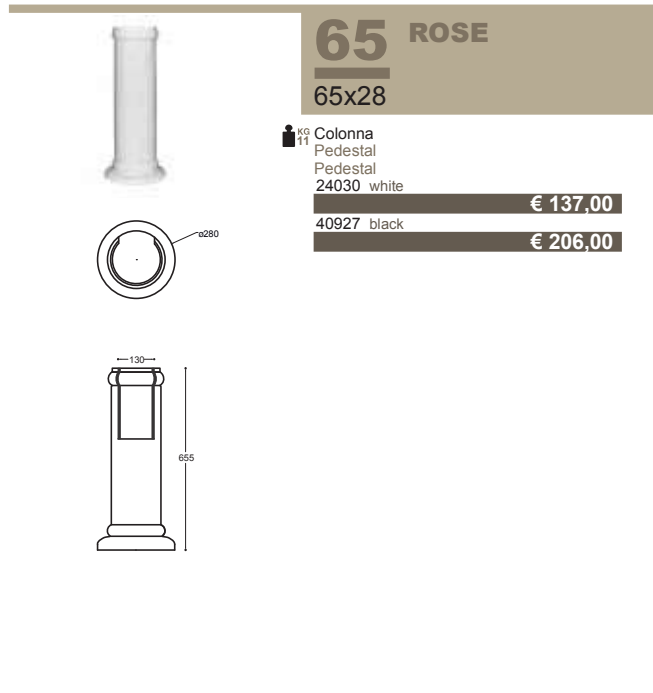

65 ROSE

65x28

- KG 11** Colonna
Pedestal
Pedestal
24030 white
- € 137,00**
- 40927 black
- € 206,00**

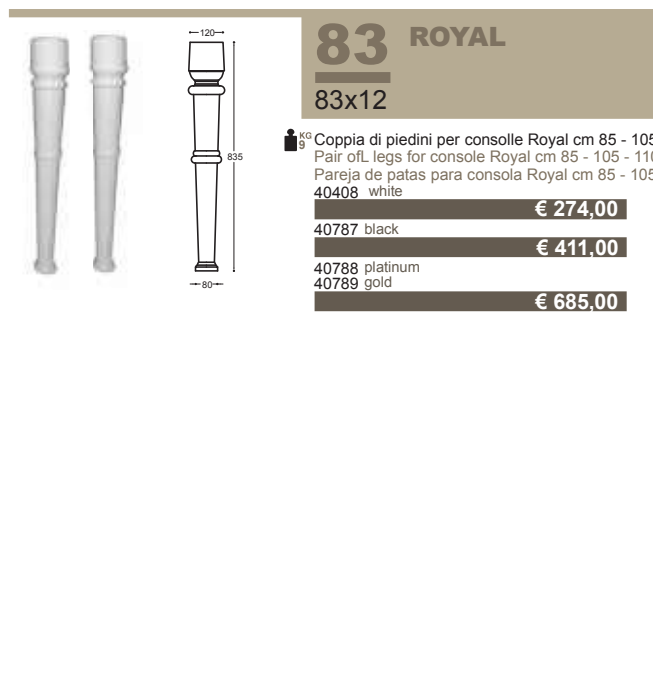

83 ROYAL

83x12

- KG 09** Coppia di piedini per consolle Royal cm 85 - 105 - 110
Pair of legs for console Royal cm 85 - 105 - 110
Pareja de patas para consola Royal cm 85 - 105 - 110
- 40408 white
- € 274,00**
- 40787 black
- € 411,00**
- 40788 platinum
- 40789 gold
- € 685,00**

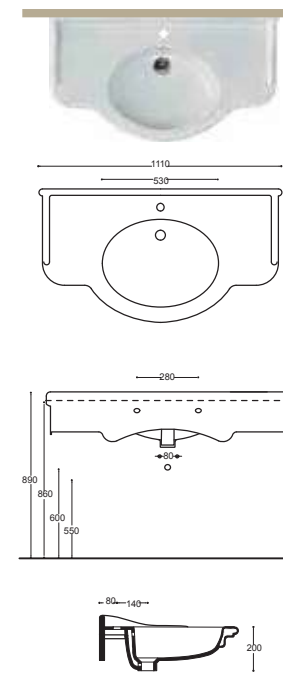

110 ROYAL

110x61



- KG 34** Consolle Royal cm 110 con troppopieno
Royal console cm 110 with overflow
Consola Royal cm 110 con rebosadero
- | | |
|--|---|
| Monoforo
One tap hole
Para monomando | Tre fori
Three tap hole
Tres agujeros |
| 40129 white | 40129-3F white |
| € 742,00 | |
| 40774 black | 40774-3F black |
| € 1.113,00 | |

- KG 05** Coppia di piedini
Pair of legs
Pareja de patas
- 40408 white
- € 274,00**
- 40787 black
- € 441,00**
- 40788 platinum
- 40789 gold
- € 685,00**

ARTICOLI SUPPLEMENTARI ADDITIONAL ITEMS ARTICULOS ADICIONALES

- KG 01** Fissaggi per lavabo
Fixings for washbasin
Anclajes para lavabo
- 30020
- € 4,50**

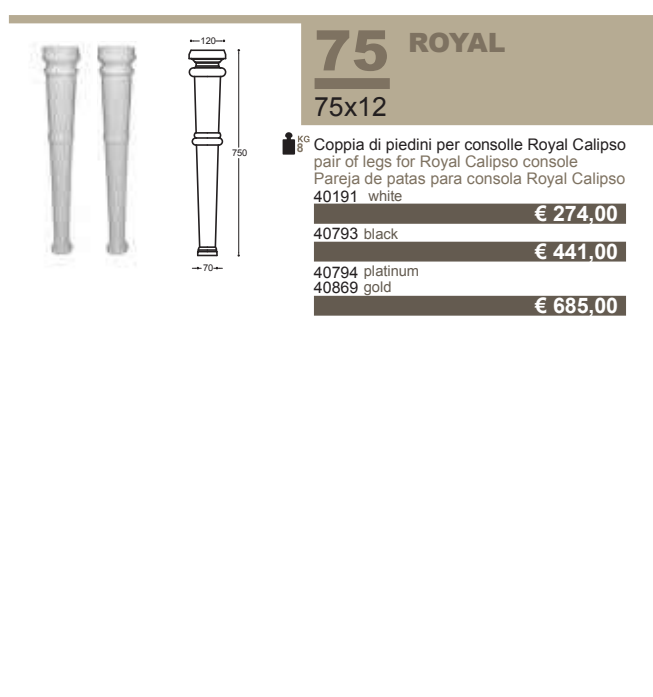

75 ROYAL

75x12

- KG 08** Coppia di piedini per consolle Royal Calipso
pair of legs for Royal Calipso console
Pareja de patas para consola Royal Calipso
- 40191 white
- € 274,00**
- 40793 black
- € 441,00**
- 40794 platinum
- 40869 gold
- € 685,00**

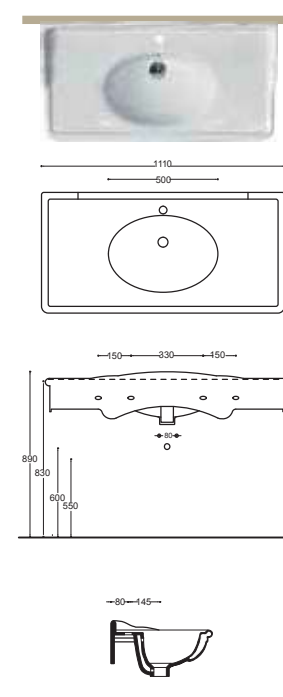

110 ROYAL

110x55



- KG 41** Consolle Royal Calipso con troppopieno
Royal Calipso console with overflow
Consola Royal Calipso con rebosadero
- | | |
|--|---|
| Monoforo
One tap hole
Para monomando | Tre fori
Three tap hole
Tres agujeros |
| 30060 white | 30060-3F white |
| € 742,00 | |
| 40775 black | 40775-3F black |
| € 1.113,00 | |

- KG 05** Coppia di piedini
Pair of legs
Pareja de patas
- 40191 white
- € 274,00**
- 40793 black
- € 441,00**
- 40794 platinum
- 40869 gold
- € 685,00**

ARTICOLI SUPPLEMENTARI ADDITIONAL ITEMS ARTICULOS ADICIONALES

- KG 01** Fissaggi per lavabo
Fixings for washbasin
Anclajes para lavabo
- 30020
- € 4,50**



59 ROSE

59x37



Bidet con troppopieno
Bidet with overflow
Bidé con rebosadero

Monoforo Tre fori
One tap hole Three tap hole
Para monomando Tres agujeros

24040 white 24040-3F white **€ 287,00**

40928 black 40928-3F black **€ 431,00**

ARTICOLI SUPPLEMENTARI ADDITIONAL ITEMS ARTICULOS ADICIONALES



Fissaggio per vaso e bidet
Fixings for WC - bidet
Anclajes para inodoro - bidé

520/A **€ 4,50**

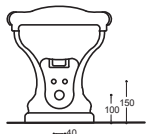
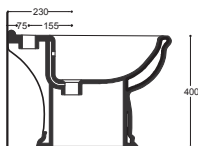
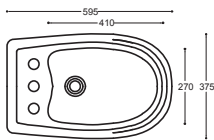

57 ROSE

57x38



WC scarico a parete
WC wall trap
Inodoro salida H

24003 white **€ 321,00**

40929 black **€ 482,00**

ARTICOLI SUPPLEMENTARI ADDITIONAL ITEMS ARTICULOS ADICIONALES



Coprivaso in resina termoindurente - cerniere cromo
Thermosetting resin seat cover - chrome hinges
Asiento de resina termoindurente - bisagras cromo

24050 white **€ 76,00**

40952 black
24052 wood **€ 130,00**



Coprivaso frizionato in resina termoindurente - cerniere cromo
Thermosetting resin soft close seat cover - chrome hinges
Asiento amortiguado de resina termoindurente - bisagras cromo

40415 white **€ 180,00**

40953 black
40418 wood **€ 240,00**



Fissaggio per vaso e bidet
Fixings for WC - bidet
Anclajes para inodoro - bidé

520/A **€ 4,50**

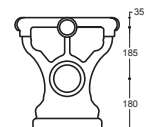
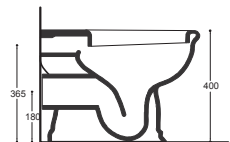
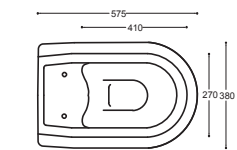

57 ROSE

57x38



WC scarico a pavimento
WC floor trap
Inodoro salida V

24004 white **€ 321,00**

40930 black **€ 482,00**

ARTICOLI SUPPLEMENTARI ADDITIONAL ITEMS ARTICULOS ADICIONALES



Coprivaso in resina termoindurente - cerniere cromo
Thermosetting resin seat cover - chrome hinges
Asiento de resina termoindurente - bisagras cromo

24050 white **€ 76,00**

40952 black
24052 wood **€ 130,00**



Coprivaso frizionato in resina termoindurente - cerniere cromo
Thermosetting resin soft close seat cover - chrome hinges
Asiento amortiguado de resina termoindurente - bisagras cromo

40415 white **€ 180,00**

40953 black
40418 wood **€ 240,00**



Fissaggio per vaso e bidet
Fixings for WC - bidet
Anclajes para inodoro - bidé

520/A **€ 4,50**

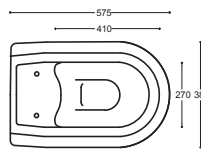



73 ROSE

73x39



KG 28 WC monoblocco scarico a parete
Close - coupled WC wall trap
Inodoro para tanque bajo salida H

24001 white **€ 330,00**

40931 black **€ 495,00**

KG 15 Cassetta monoblocco
Close - coupled cistern
Tanque bajo

24014 white **€ 103,00**

40933 black **€ 155,00**

ARTICOLI SUPPLEMENTARI ADDITIONAL ITEMS ARTICULOS ADICIONALES

KG 4 Coprivaso in resina termoindurente - cerniere cromo
Thermosetting resin seat cover - chrome hinges
Asiento de resina termoindurente - bisagras cromo

24050 white **€ 76,00**

40952 black **€ 130,00**
24052 wood

KG 4 Coprivaso frizionato in resina termoindurente - cerniere cromo
Thermosetting resin soft close seat cover - chrome hinges
Asiento amortiguado de resina termoindurente - bisagras cromo

40415 white **€ 180,00**

40953 black **€ 240,00**
40418 wood

KG 0,003 Fissaggio per vaso e bidet
Fixings for WC - bidet
Anclajes para inodoro - bidé

520/A **€ 4,50**

KG 1 Meccanismo di scarico
Mechanism for close - coupled cistern
Mecanismo de descarga

30090 **€ 38,00**

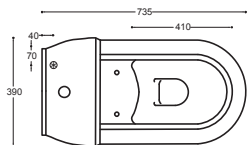

* Entrata acqua
* Inlet water
* Entrada agua

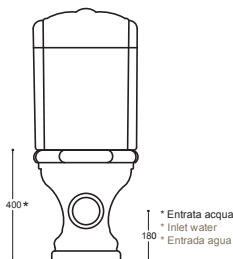
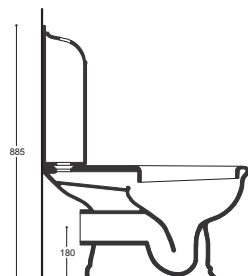

* Entrata acqua
* Inlet water
* Entrada agua



73 ROSE

73x39



KG 28 WC monoblocco scarico a pavimento
Close - coupled WC floor trap
Inodoro para tanque bajo salida V

24002 white **€ 330,00**

40932 black **€ 495,00**

KG 15 Cassetta monoblocco
Close - coupled cistern
Tanque bajo

24014 white **€ 103,00**

40933 black **€ 155,00**

ARTICOLI SUPPLEMENTARI ADDITIONAL ITEMS ARTICULOS ADICIONALES

KG 4 Coprivaso in resina termoindurente - cerniere cromo
Thermosetting resin seat cover - chrome hinges
Asiento de resina termoindurente - bisagras cromo

24050 white **€ 76,00**

40952 black **€ 130,00**
24052 wood

KG 4 Coprivaso frizionato in resina termoindurente - cerniere cromo
Thermosetting resin soft close seat cover - chrome hinges
Asiento amortiguado de resina termoindurente - bisagras cromo

40415 white **€ 180,00**

40953 black **€ 240,00**
40418 wood

KG 0,003 Fissaggio per vaso e bidet
Fixings for WC - bidet
Anclajes para inodoro - bidé

520/A **€ 4,50**

KG 1 Meccanismo di scarico
Mechanism for close - coupled cistern
Mecanismo de descarga

30090 **€ 38,00**

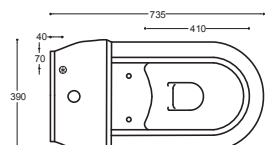

* Entrata acqua
* Inlet water
* Entrada agua

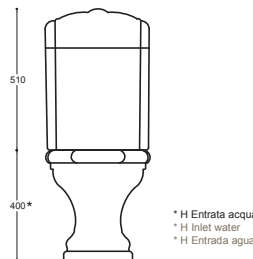
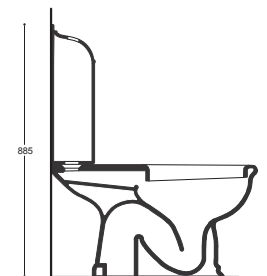

* H Entrata acqua
* H Inlet water
* H Entrada agua



ISTITUTO PER LA TUTELA DEI PRODUTTORI ITALIANI

Made in Italy 100% Certificate

REGISTRAZIONE N° IT01.IT/698.023.M

SI ATTESTA CHE
This is to certify that

CERAMICA ALTHEA

E' UN MARCHIO CERTIFICATO AVENTE I REQUISITI DEL
SISTEMA IT01 - 100% QUALITA' ORIGINALE ITALIANA
acts according to system IT01 - 100% Original Italian Quality

QUESTA CERTIFICAZIONE E' INOLTRE VALIDA PER IL SEGUENTE CAMPO APPLICATIVO:
This certificate is also valid for the following product or service range:

PRODOTTI IGIENICO SANITARI IN CERAMICA
Hygienic Sanitary Products

DITTA PRODUTTRICE E DISTRIBUZIONE
Manufacturer and distribution Company

CERAMICA ALTHEA SPA
Viale delle Industrie, 9 - 01033 Civita Castellana (VT)

SISTEMA IT01 - 100% QUALITA' ORIGINALE ITALIANA
The certified Company:

QUESTI PRODOTTI SONO:
These products are:

A - FABBRICATI INTERAMENTE IN ITALIA
Entirely Made in Italy

B - REALIZZATI CON SEMILAVORATI (ITALIANI)
Made with Italian components

C - COSTRUITI CON MATERIALI NATURALI
DI QUALITA' E DI PRIMA SCELTA
Made with natural top quality materials

D - REALIZZATI CON DISEGNI E PROGETTAZIONE
ESCLUSIVI DELL'AZIENDA

Made according to the Company's exclusive styles and designs

E - COSTRUITI ADOTTANDO LE LAVORAZIONI
ARTIGIANALI, TRADIZIONALI TIPICHE ITALIANE

Made according to the typical Italian craftsmanship and tradition

Organismo Aaseverante
Supporting unit:
PROMINDUSTRIA SPA



Stamp / Trade Mark
Timbro dell'istituto

WALTER MARTINI
President

NAZZARENO VITA
Director

MILANO, 28/02/2013

LA VALIDITA' DEL PRESENTE CERTIFICATO MADE IN ITALY E' SUBORDINATA AL RIESAME COMPLETO DEL SISTEMA CON PERIODICITA' ANNUALE
The validity of this Made in Italy Certificate is subjected to a periodical complete annual inspection



CERTIFICATO DEL SISTEMA DI GESTIONE PER LA QUALITÀ QUALITY MANAGEMENT SYSTEM CERTIFICATE

Si dichiara che il sistema di gestione per la Qualità dell'Organizzazione:
We certify that the Quality Management System of the Organization:

Reg. No: 3619 - A

**CERAMICA ALTHEA
S.p.A.**

Indirizzo/Address:

Loc. Prataroni - Zona Industriale
01030 Civita Castellana VT Italia

È conforme alla norma/Is in compliance with the standard:

UNI EN ISO 9001:2008
ISO 9001:2008

Per i seguenti prodotti-servizi/For the following products-services:

Progettazione e produzione di articoli igienico-sanitari in ceramica
Design and manufacturing of ceramic sanitary wares

EA: 15

Il mantenimento della certificazione è soggetto a sorveglianza annuale e subordinato al rispetto dei requisiti essenziali CERMET.
Maintenance of the certification is subject to annual survey and dependent upon the observance of CERMET basic requirements.

Rilascio certificato/Certificate issuance: 2003-03-20
Ultima modifica/Last modification: 2012-05-23
Prossimo rinnovo/Following renewal: 2015-03-19

Direttore Commerciale e Operativo
Sales and Operations Manager
Gianpiero Belcredi

Direttore Generale
General Manager
Rodolfo Trippodo



SOC N° 007A
SEA N° 0100
PRO N° 0008

FSM N° 006
SIS N° 0060



 **CONDIZIONI GENERALI DI VENDITA**

ORDINAZIONI:

dovranno essere passate alla società e dalla stessa confermate, sia per i prezzi sia per il termine di consegna. La merce è venduta franco fabbrica e viaggia, in ogni caso, a rischio e pericolo del committente.

TRASPORTO :

rimane sempre a carico del committente per conto del quale la società esegue la spedizione.

IMBALLO :

effettuato su pallets verrà addebitato il costo del 3% della fornitura.

PREZZI:

la società si riserva la facoltà di variare i prezzi senza alcun preavviso. In ogni caso i prezzi validi saranno quelli del listino in vigore al momento della consegna. Tutti i prezzi si intendono esclusi IVA.

PAGAMENTI:

i pagamenti debbono essere effettuati, esclusivamente, presso la sede della società fornitrice, salvo patto contrario espresso. Il mancato pagamento di una eventuale precedente fornitura autorizza la Società Ceramica Althea Spa a sospendere le forniture e ad annullare eventuali ordini in portafoglio.

In caso di contestazione di qualsiasi natura il committente non ha diritto di sospendere i pagamenti.

CONSEGNA:

i termini di consegna sono puramente indicativi. In ordine a tali termini, pertanto, la Società fornitrice non potrà assumere, responsabilità di qualsiasi genere, salvo i casi di pattuizione espressa.

RECLAMI:

dovranno pervenire alla ns. Sede non oltre otto giorni dal ricevimento della merce. In ogni caso non si accettano merci di ritorno, senza che sia intercorso un accordo in tal senso con la fornitrice.

RISERVA DI PROPRIETA':

fino a che il pagamento non sia stato completato la merce rimane di proprietà della fornitrice.

DATI RIGUARDANTI IL COMMITTENTE:

il committente è responsabile di tutti i dati identificativi, in particolare, per quanto si riferisce alle norme relative all'anagrafe tributaria (Codice Fiscale).

DOMICILIO LEGALE:

per qualsiasi controversia, competente è il Foro di Viterbo (Italia).

INTERESSI MORATORI:

qualora si verificassero ritardi dei pagamenti verranno addebitati gli interessi al tasso praticato dagli istituti di Credito all'atto dell'addebito.

DIMENSIONI

Le misure di ciascun lavabo sono da considerarsi indicative e suscettibili di variazioni a causa delle caratteristiche peculiari della lavorazione ceramica.

Ceramica Althea Spa si riserva il diritto di apportare, in qualsiasi momento modifiche tecniche, costruttive e dimensionali utili al miglioramento della produzione.

Le tonalità degli smalti possono subire lievi variazioni da considerarsi in tolleranza a causa delle caratteristiche peculiari della lavorazione ceramica.

 **GENERAL SALE TERMS**

ORDERS:

must be placed with the firm that will confirm both prices and delivery terms. Goods are sold on an ex-factory basis and transport is carried out at the customer's own risk.

TRANSPORT:

is always to be paid by the customer on whose behalf the firm may ship the goods.

PACKAGING :

on pallets, 3% of the consignment value will be debited.

PRICES:

the firm reserves the right to vary prices without any previous notice. In any case, the prices to be considered valid are those contained in the price-list in force at the time of delivery.

Prices do not include V.A.T.

PAYMENT:

must be made exclusively to the supplying firm unless otherwise agreed upon. Failure to pay a previous supply allows the firm Ceramica Althea Spa to stop shipping goods and cancel any pending order. In case of any claims, the customer must not suspend payment.

DELIVERY:

dates are merely approximate. Consequently the supplying firm bears no responsibility for delivery dates, unless otherwise agreed upon.

WEIGHT AND SIZES:

these are approximate and therefore the firm bears no responsibility for them.

CLAIMS:

must be submitted to our head office within 8 days upon receipt of the goods. Goods will not be accepted back unless otherwise agreed upon with the manufacturer.

RIGHTS OF OWNERSHIP:

until payment is fully settled, the goods remain the property of the supplying firm.

CUSTOMER DETAILS:

the customer is responsible for all identification details provided, particularly for those referring to the tax register office (tax code).

LEGAL RESIDENCE:

for any controversy the competent court is the Court of Viterbo (Italy).

INTEREST ON DELAYED PAYMENTS:

should there be delay in payments, interest will be charged at the rate fixed by credit institutions at the moment of debiting.

DIMENSIONS

The measures of each basin are to be considered as approximate and susceptible to variations because of the specific characteristics of the ceramic workmanship.

Ceramica Althea Spa reserves the right to make, at any moment, technical, constructive and dimensional changes useful to improve the production.

 **CONDICIONES GENERALES DE VENTA**

PEDIDOS:

los pedidos deben ser enviados a la sociedad y confirmados por ésta, sea por los precios y la fecha de entrega. La mercancía es vendida franco almacén y siempre viaja por cuenta y riesgo del comprador.

TRANSPORTE:

siempre es a cargo del comprador por demanda del cual la sociedad efectúa la expedición.

EMBALAJE:

se realiza en palets y se adeudará el 3% del coste total del suministro.

PRECIOS:

la sociedad se reserva el derecho de modificar los precios sin preaviso. En todos los casos los precios válidos serán los de la tarifa vigente en el momento de la entrega. Los precios no incluyen I.V.A.

PAGOS:

los pagos deben ser efectuados exclusivamente a la sociedad vendedora, a excepción de previo pacto. El pago pendiente de un suministro ya servido autoriza a Ceramica Althea Spa a suspender el suministro y anular los pedidos en cartera. En el caso de incidencias de cualquier naturaleza el comprador no tiene derecho a retrasar/suspender los pagos.

ENTREGA:

la fecha de entrega es sólo orientativa. Según lo indicado la sociedad suministradora no podrá asumir ninguna responsabilidad salvo en los casos de previo pacto.

PESOS Y MEDIDAS:

ambos son aproximados. No se asumen responsabilidades por ellos siendo que las indicaciones de esta lista de precios son de carácter orientativo.

RECLAMACIONES:

tendrán que llegar a nuestra oficina dentro de los ocho días de la recepción de la mercancía y no después. En ningún caso se aceptará devolución de mercancía sin la autorización expresa de la sociedad suministradora.

RESERVA DE PROPIEDAD:

hasta que el pago no sea efectivo la mercancía es propiedad de la sociedad vendedora.

DATOS REFERENTES AL COMPRADOR:

el comprador es responsable de la correcta utilización de sus datos de identificación fiscal, en particular en lo referente a las normas relativas al Registro de Contribuyentes.

DOMICILIO LEGAL:

por cualquier controversia es competente el Foro de Viterbo (Italia).

INTERESES DE MOROSIDAD:

en el caso de retraso en los pagos se adeudarán los intereses según la tasa indicada por las Entidades Bancarias al momento del adeudo.

MEDIDAS

Las medidas de cada lavabo son orientativas y susceptibles de variaciones por las características peculiares de la fabricación de la cerámica.

Ceramica Althea Spa se reserva el derecho de aportar, en cualquier momento, cambios técnicos, constructivos, y de medida para la optimización de la producción.

Las tonalidades de los esmaltes pueden sufrir leves variaciones sujetas a la normativa, dadas las características peculiares de la producción de la cerámica.

 **ALLGEMEINE VERKAUFSBEDINGUNGEN**

BESTELLUNGEN:

diese müssen im Unternehmen eingegangen sein und von ihnen bestätigt worden sein, sowohl in Bezug auf die Preise, als auch auf die Lieferzeiten. Die Ware wird frei Fabrik verkauft und reist in jedem Fall auf Risiko und Gefahr des Auftraggebers.

TRANSPORT:

immer zu Lasten des Auftraggebers, für den das Unternehmen die Spedition ausführt.

VERPACKUNG:

ausgeführt auf Palletten werden Kosten in Höhe von 3% der Lieferung auferlegt.

PREISE:

das Unternehmen behält sich die Befugnis vor, die Preise ohne jede Vorankündigung abzuändern. In jedem Fall werden die Preise der Preisliste angerechnet, die im Moment der Warenübergabe gültig ist. Alle Preise verstehen sich ausschliesslich MWST.

BEZAHLUNG:

die Bezahlungen dürfen ausschliesslich im Sitz der Lieferfirma ausgeführt werden, soweit nicht anders vereinbart. Das Ausbleiben der Zahlung einer eventuell vorhergehenden Lieferung autorisiert das Unternehmen Ceramica Althea Spa dazu, die Lieferung aufzuheben und eventuell anstehende Bestellungen zu annullieren. Bei Streitigkeiten jeglicher Natur hat der Auftraggeber nicht das Recht, die Zahlungen aufzuheben.

LIEFERUNG:

die Lieferbedingungen sind rein indikativ. In Bezug auf diese Bedingungen kann deshalb die Lieferfirma keinerlei Verantwortung übernehmen, soweit nicht anders vereinbart worden ist.

GEWICHTE UND MASSE:

beide sind annähernd. Man übernimmt keinerlei Verantwortung über diese, da die Angaben in der beigelegten Preisliste nur indikativen Charakter haben.

BESCHWERDEN:

diese müssen in unserem Firmensitz binnen acht Tagen ab Erhalt der Ware eingehen. In keinem Fall werden Warenrücksendungen akzeptiert, ohne dass mit der Lieferfirma vorher eine Vereinbarung in diesem Sinne getroffen worden ist.

EIGENTUMSVORBEHALT:

bis zur vollständigen Bezahlung bleibt die Ware Eigentum der Lieferfirma.

DATEN ÜBER DEN AUFTRAGGEBER:

der Auftraggeber ist Verantwortlich für alle angegebenen Daten, insbesondere für diejenigen, die sich auf fiskalische Angaben beziehen (Steuernummer).

GESETZLICHER WOHNSITZ:

für jegliche Streitigkeiten ist das Amtsgericht in Viterbo (Italien) zuständig.

VERZUGSZINSEN:

falls bei der Bezahlung Verspätungen eintreten, werden Zinsen in Höhe von dem Zinssatz auferlegt, der von den Kreditinstituten zum Moment des Zahlungseinzugs angewandt wird.